

家登精密工業 興櫃法人說明會

邱銘乾 董事長

2009/12/24

股票代碼:3680



Gudeng

道與術



道

“家”喻戶曉，“登”峰造極

Gudeng Gudeng 久久長長

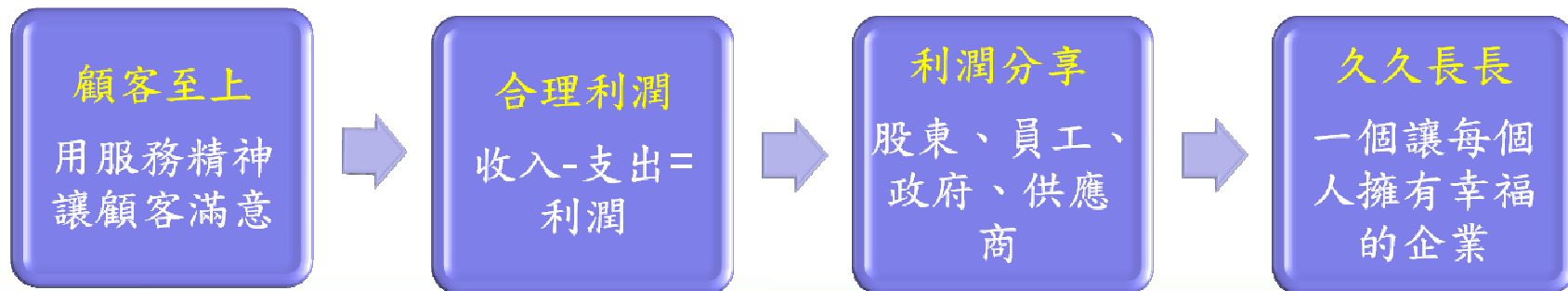

術

Critical Material Handling and Beyond

Critical Material Protection, Transportation & Storage

關鍵性貴重材料元件物品之保護、傳送與儲存解決方案

簡報大綱

1. 關於家登
2. 光罩、晶圓與傳載解決方案
(Mask & Wafer Handling Solutions)
3. 競爭優勢
4. 營運概況
5. 公司未來展望



公司簡介

- 成立日期：1998年3月20日
- 實收資本額：2億8千萬元
- 員工人數：157人
- 所在位置：台北縣土城市中央路四段2號9樓(總公司)
台北縣樹林市八德街426號(工廠)
- 董事長兼總經理：邱銘乾
- 主要產品：
 - * 光罩傳載解決方案(Mask Handling Solution)
 - * 晶圓傳載解決方案(Wafer Handling Solution)
 - * 光罩與晶圓載具清洗服務
 - * 客製化設計與產品服務



公司沿革

- 1998: 家登精密工業成立，初期從事傳統模具製造
- 1999: 轉型切入半導體業務
- 2000: 切入光罩載具市場與tsmc合作開發黃光微影用零組件
- 2001: 光罩SMIF POD零組件通過tsmc認證
- 2002: 建class 1 無塵室
- 2003: 6吋光罩盒(Shipping Box)通過tsmc認證
- 2004: 與tsmc成功合作開發高端光罩SMIF POD，讓tsmc 12吋廠90nm順利量產
- 2005: 獲頒tsmc感謝狀，感謝家登對其黃光微影工程的貢獻幫tsmc解決光罩微污染問題



公司沿革

- 2006：開發出光罩Glass side清洗機
- 2007：與世界第一大半導體搬運設備製造廠策略合作開發設備
導入SAP ERP系統
切入晶圓載具市場-PEEK cassette
榮獲「國家磐石獎」以及榮獲「青年創業楷模」
- 2008：參與SEMI 18吋晶圓載具研發
榮獲「小巨人獎」



公司沿革

- 2009：獲頒「產業創新成果獎」與「產業科技發展獎傑出青年創新類」
「18吋晶圓載具開發」通過經濟部主導性產品開發計劃申請





光罩、晶圓與傳載解決方案 (Mask & Wafer Handling Solutions)

Our Product

Mask Handling Solutions



Our Product

Wafer Handling Solutions



光罩與晶圓 (Mask & Wafer)

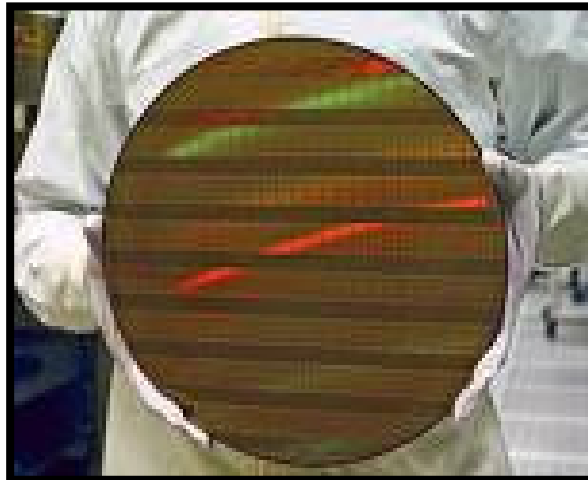
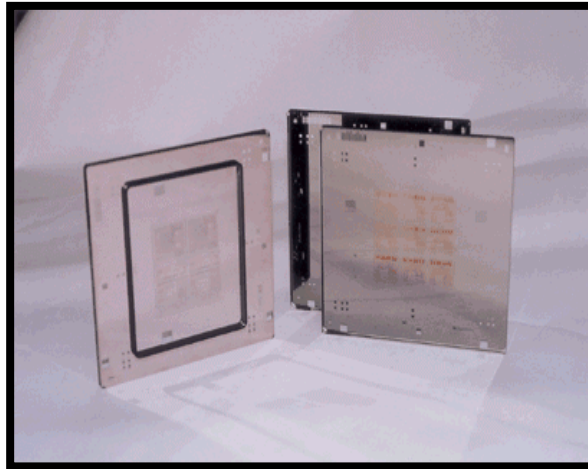

橫跨產業

IC

FPD

LED

Solar

MEMS

PCB (載板)

GaAs (砷化鎵)

光罩與晶圓 (Mask & Wafer)

關鍵性貴重材料元件之保護、傳送與儲存整合解決方案的提供者。



- 32 奈米光罩:
一個關鍵光罩成本超過一百萬美元，一個32奈米的產品將會涵蓋超過60個光罩，成本總共將超過~一千萬美元。



- 32 奈米晶圓:
每一個晶圓成本超過五萬美元，一個 FOUP 涵蓋了25個晶圓，成本總共超過~1百萬美元。

We are very vulnerable!

光罩 (Mask)



a) Design pattern

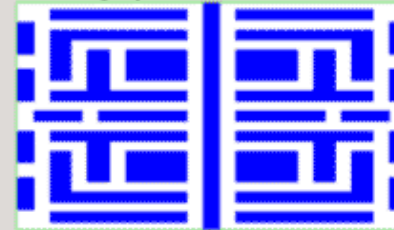

b) Pixelated mask

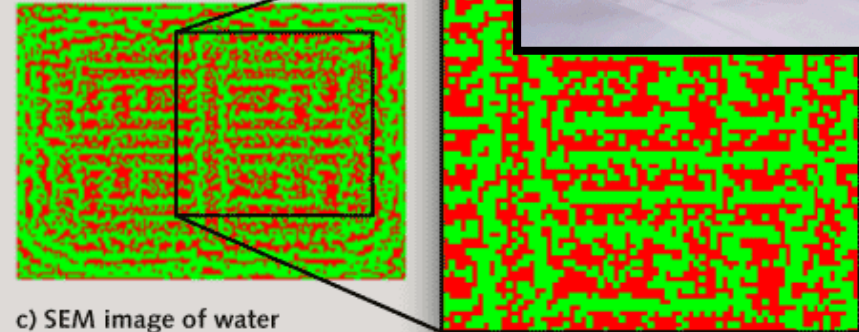

c) SEM image of water

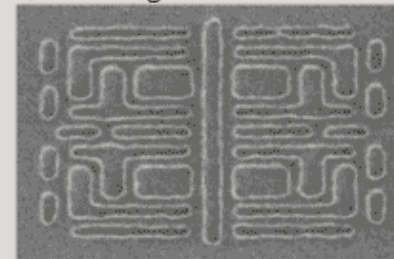

A portion of the 65nm metal 1 design (a) is converted to a pixelated phase mask design (b), where red represents 180° phase shift pits and green represents 0°, and projected by the stepper forming the resist image in (c).

WaferNews source: Intel Corp.

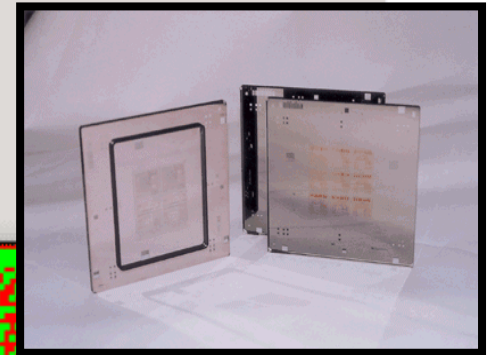

光罩 (Mask) 的防護

ESD
靜電防護

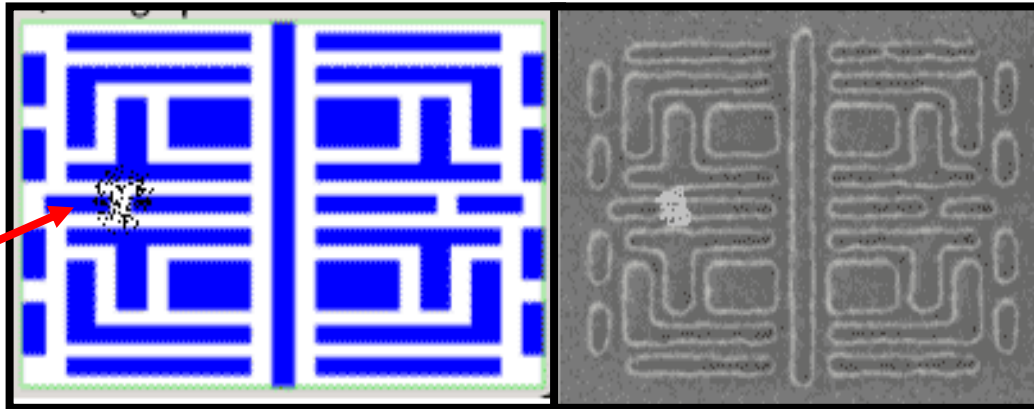

ESD on mask
->circuit short
->chip fail
須要“靜電防護”

Haze
霧化

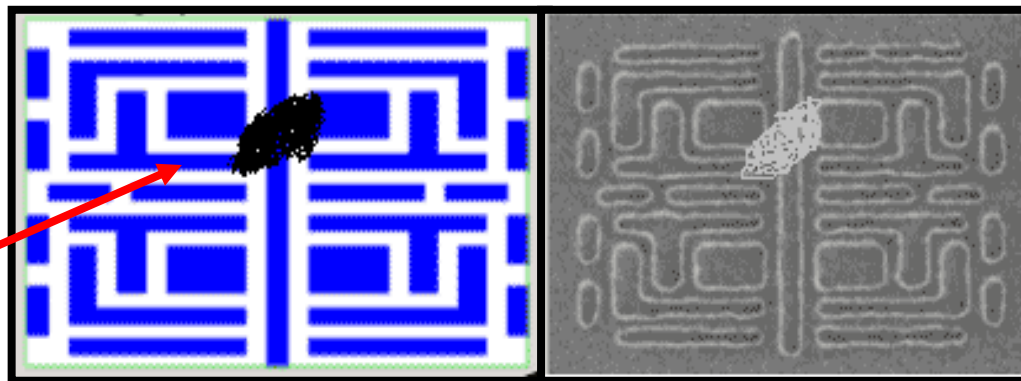

Haze on mask
->circuit short
->chip fail
須要“微污染防治”

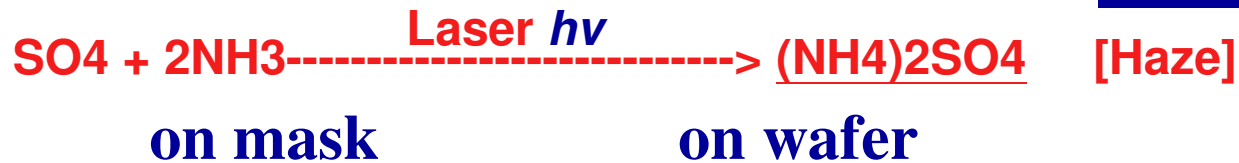

光罩 (Mask) 的載具

We are leader.

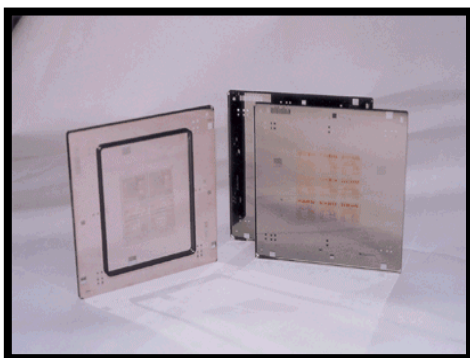

光罩廠

光罩盒 (shipping box)



晶圓廠 曝光機

光罩 SMIF Pod
高端光罩 SMIF Pod (Haze-free)

光罩 (Mask) 的微污染防護

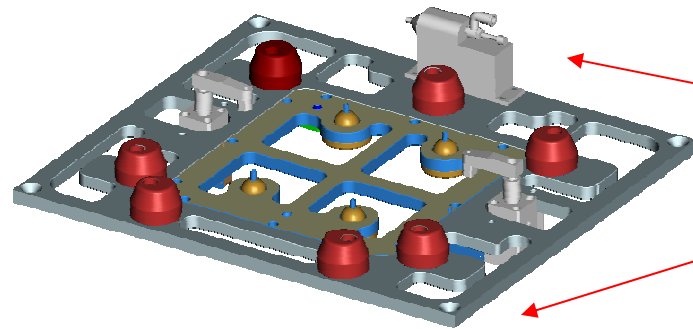
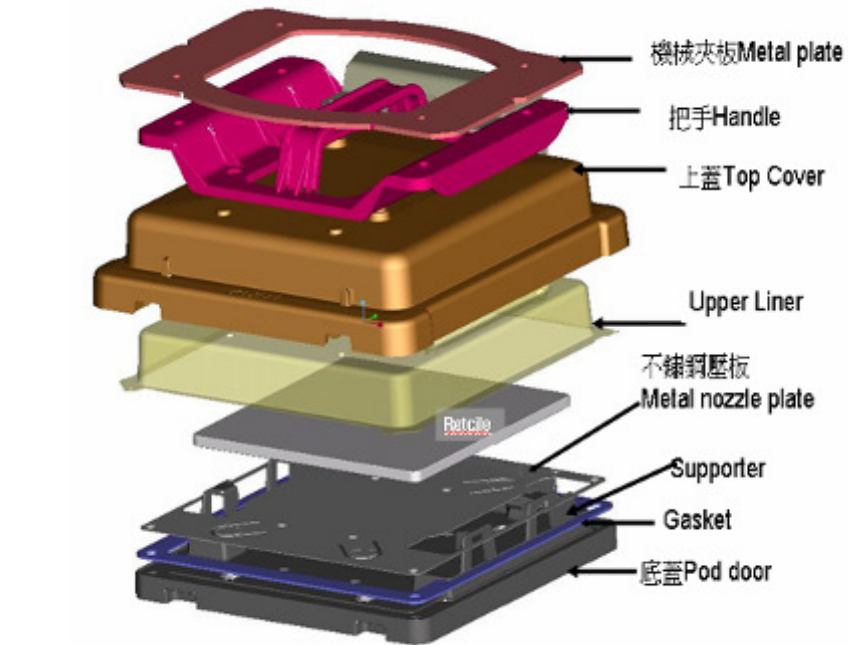

高端光罩 SMIF Pod (Haze-free)

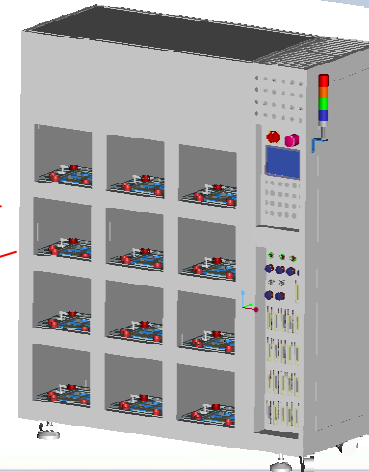
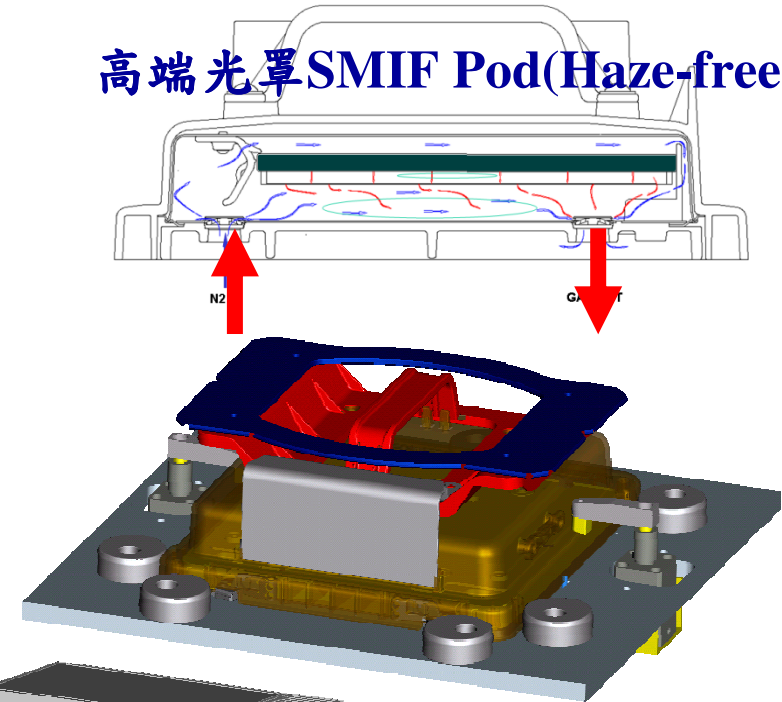

VF CLS-40R 620 RSP PURGE STOCKER

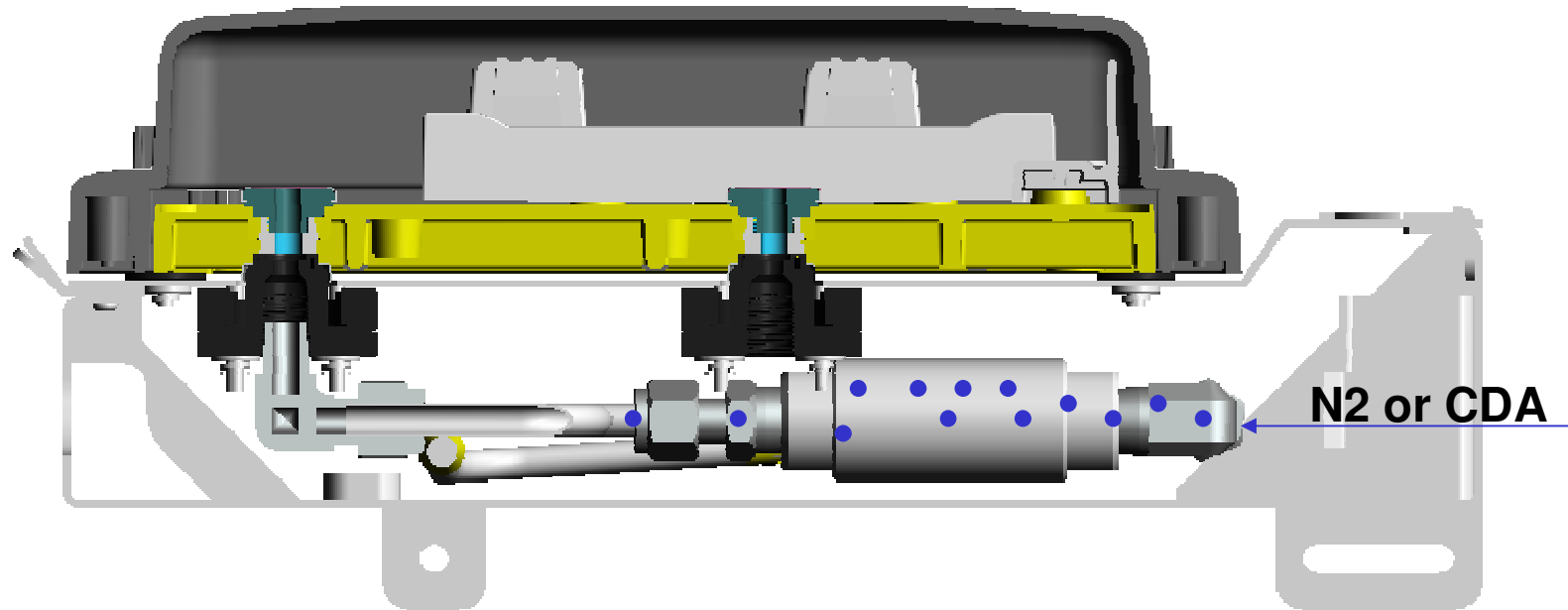

●氣體動向

VF CLS-40R 620 RSP PURGE STOCKER

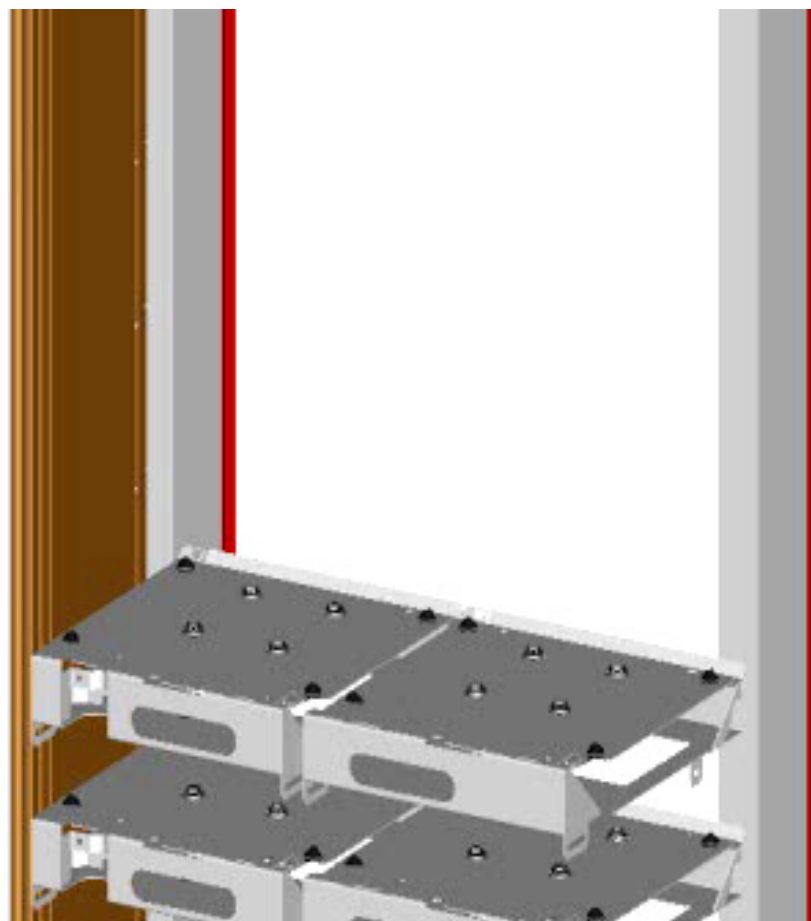

450 mm FOUP





Gudeng

Our Product

Mask Handling Solutions



Wafer Handling Solutions



年度 產品項目	2007年		2008年	
	營業收入 淨額	比重(%)	營業收入 淨額	比重(%)
光罩類	213,483	59.94%	192,489	52.70%
晶圓類	5,015	1.41%	23,068	6.32%
機台設備類	97,526	27.38%	99,347	27.20%
服務類	13,500	3.79%	20,108	5.50%
其它類	26,631	7.48%	30,261	8.28%
合計	356,155	100.00%	365,273	100.0%



Our Customers

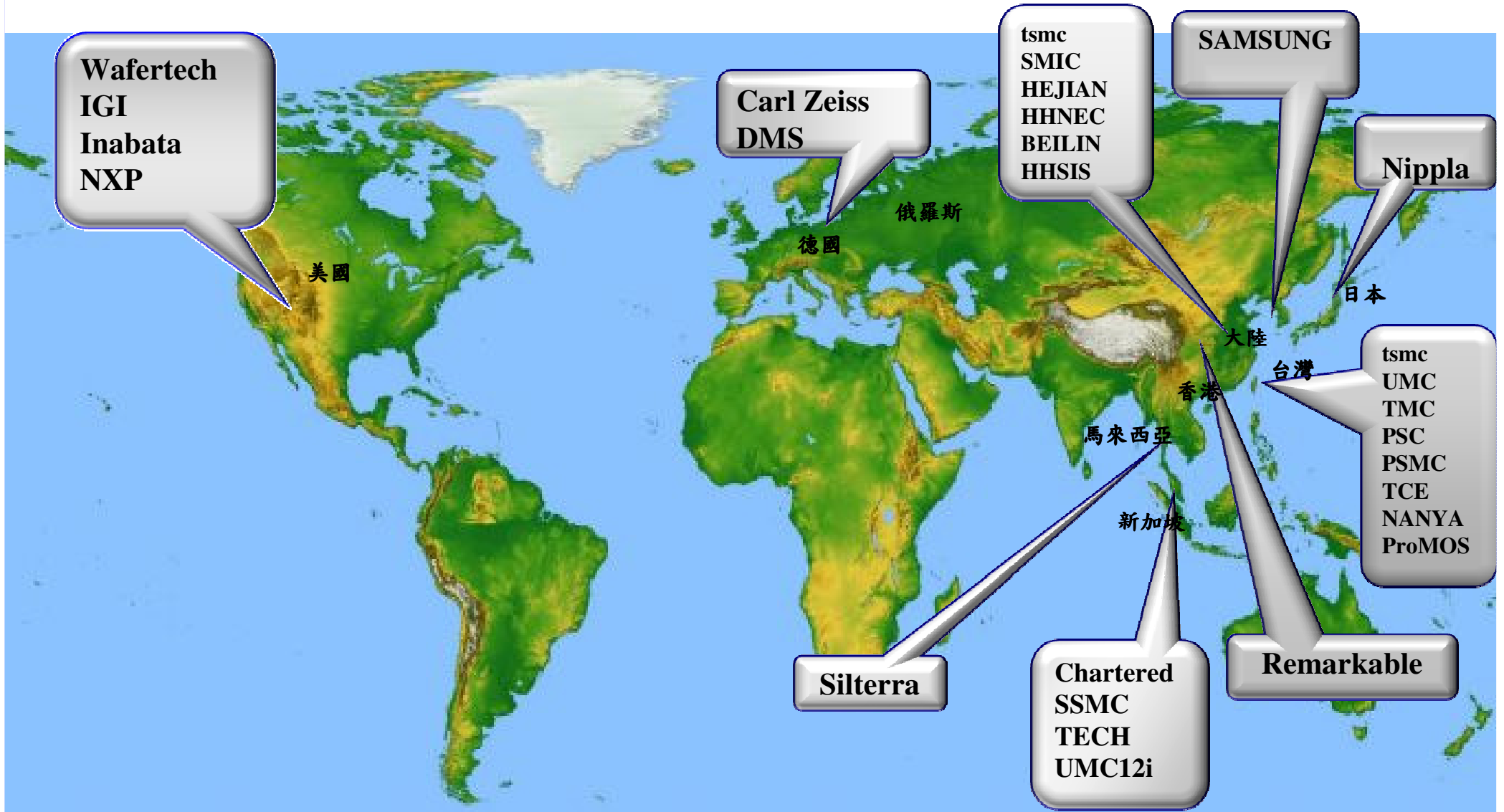

家登精密代表性客戶

[Semiconductor Manufacturers]



[Mask Shops]



[Solar cell Manufacturers]



[Wafer Growers]



[Original Equipment Manufacturers]





競爭優勢

- 光罩Haze解決方案之市場領導者，高進入障礙。
- 光罩Handling上有完整的解決方案，是市場領導者。
- 在國內半導體前段製程解決方案居領先地位。
- Mask & Wafer Handling上已建立微污染防制(AMC)技術與靜電防護(ESD)技術。
- 專注於國內外一線大廠合作機會，技術層次提昇。
- Mask Handling Solutions & Wafer Handling Solutions已橫跨各產業領域，可降低營運風險。

競爭優勢

- 以客製化服務導向，品質好、交期快與高彈性，滿足客戶需求。
- 可複製現有model於其他關鍵性貴重材料元件之解決方案。



家登精密近五年營業收入



家登精密近五年毛利率

單位：新台幣仟元

	2004年	2005年	2006年	2007年	2008年
營業收入	88,050	152,756	310,034	356,155	365,273
營業毛利	37,851	60,869	146,776	193,200	188,466
毛利率	43%	40%	47%	54%	52%



公司未來展望

CAPEX 2010(資本支出)

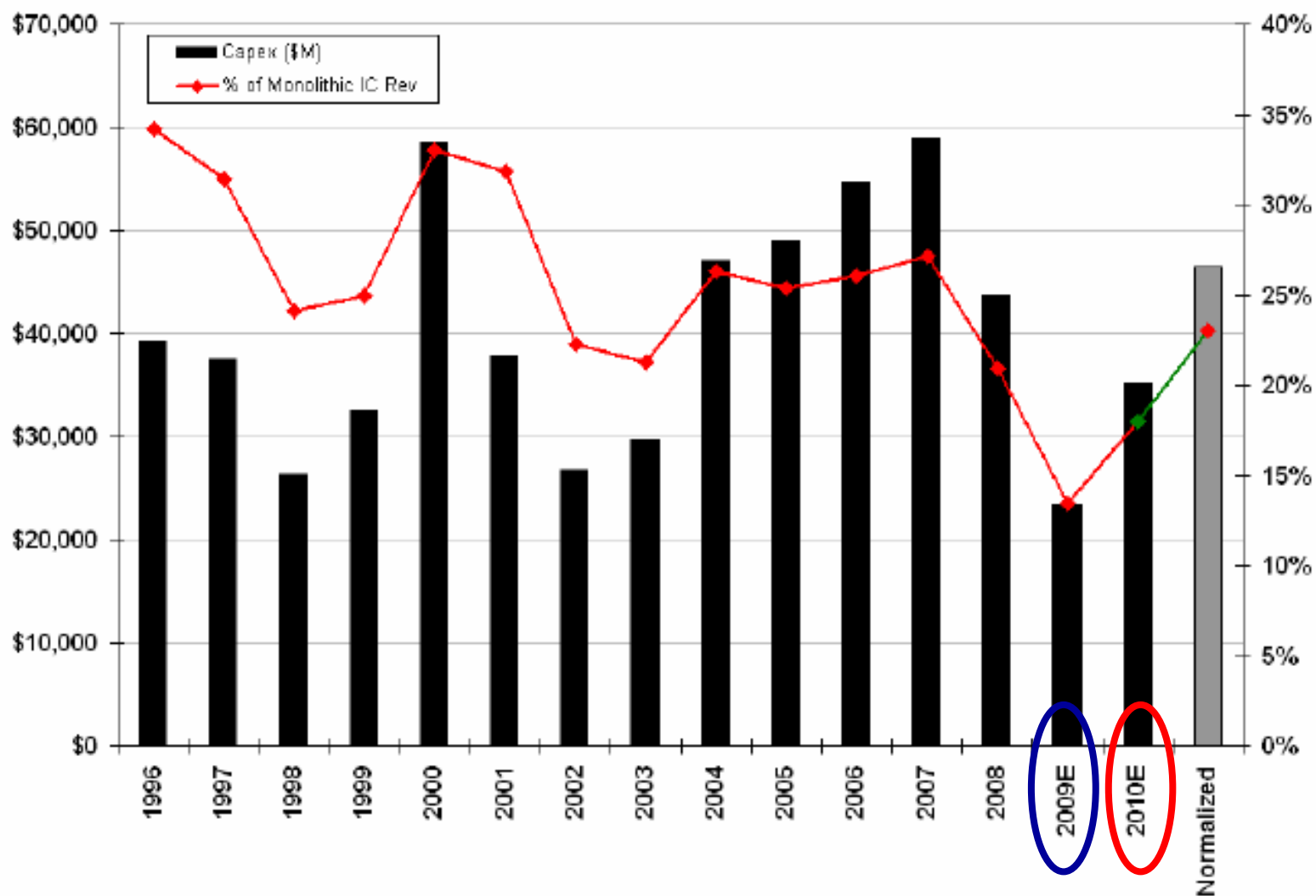

Source: Gartner, SIA, Company Reports, and Oppenheimer & Co.

NOTE: Results presented cannot and should not be viewed as an indicator of future performance.

CAPEX Datapoints

- **TSMC (+70% Y/Y in '10)**

- > \$2.7B in '09, ~\$4.5B in '10

(unit: K wspm)		Node	2008 Capacity	2009 Capacity
Fab 12	Phase 4	40/45nm	35	60
	Phase 5	32/40nm	0	30
Fab 14	Phase 3	40/45nm	5	30
Total Added Capacity			40	80
Est capex per K wspm			\$55M	\$55M
Total Capex			\$2,200	\$4,400

- **Samsung (+50% Y/Y in '10)**

- > ~4.5 Tr KRW in '09 (4.0 Tr KRW for memory), 7 Tr KRW in '10 (5.5 Tr KRW for memory)
 - > Unequivocally ramping capex up in '10 vs. '09
 - > Line 16 copper back-end, Line 10 conversion to 300mm, and Austin fab conversion to 300mm
 - > Focus on copper back-end, and double patterning – e.g. ordered 9 immersion scanners from ASML as part of 2010 expansion for Q2 delivery

- **Toshiba (+120% Y/Y in '10)**

- > 90B JPY in '09, 240B JPY in '10
 - > 40-50B JPY of capex in '10 for bricks/mortar spending for constructing Fab Y5

未來展望

關鍵性貴重材料元件物品之保護、傳送與儲存整合解決方案

<Critical Material Handling>

技術能力

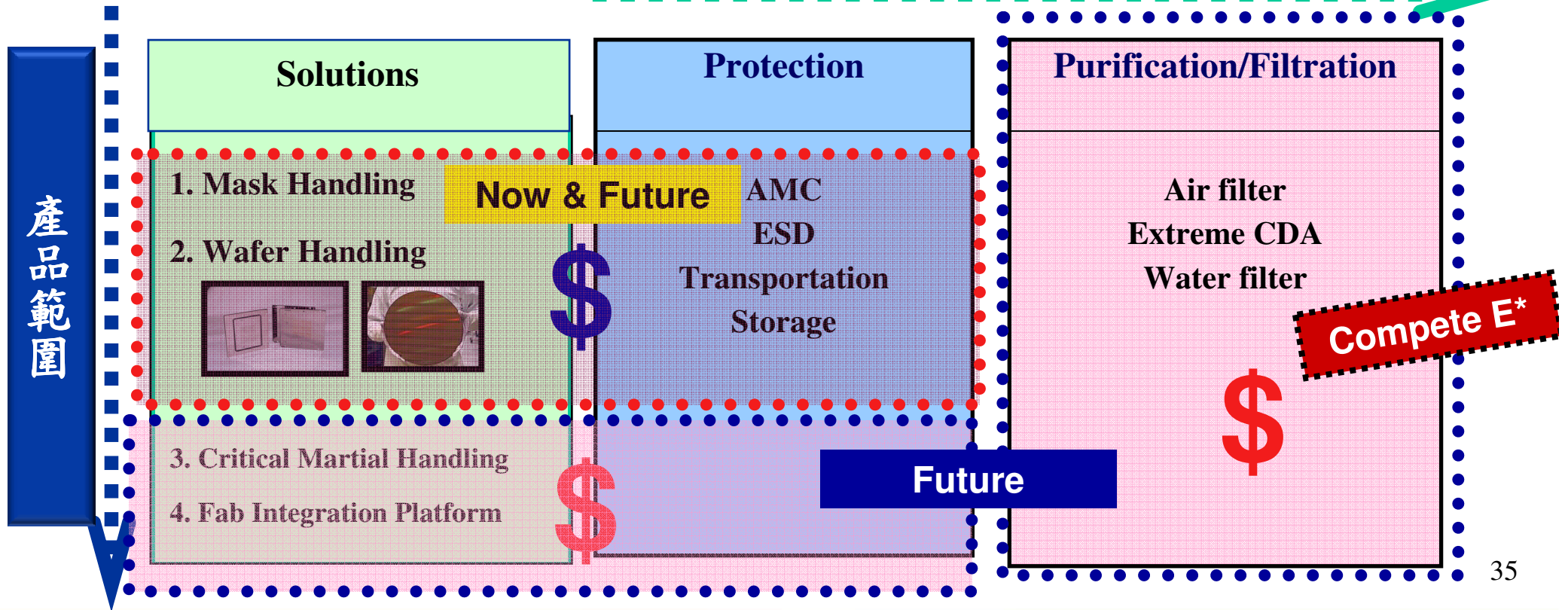

未來展望

- 2010半導體CAPEX會比2009>50%(SEMI forecast)
- 2011、2012半導體CAPEX 成長率>10%(SEMI forecast)
- 擴展Mask Handling Solutions的客戶群。
 - FPD mask shops
 - Semiconductor Manufacturers
- 擴展Wafer Handling Solutions的客戶群。
 - Semiconductor Manufacturers
 - Wafer Growers(IC+LED)
 - Solar cell Manufacturers
- 以客製服務為導向，繼續擴大Mask Handling Solutions & Wafer Handling Solutions之內容。
- 未來將於美國及中國設立營業據點，加速全球布局。

未來展望

- 複製 Mask Handling Solutions 與 Wafer Handling Solutions Model 於其他Critical Material Handling.
- Fab Integration Platform (Fab整合平台)將致力協助客戶作Cost down & Quality Improvement。
 - 技術整合，以2nd Source導入
 - 產品整合，功能提昇，upgrade 現有系統
- 技術實力將延展到氣體的濾化/純化技術，以提供客戶更完善的解決方案與產品。

Fab Integration Platform (家登Fab整合平台)



<Mask Handling Solutions> 產品藍圖

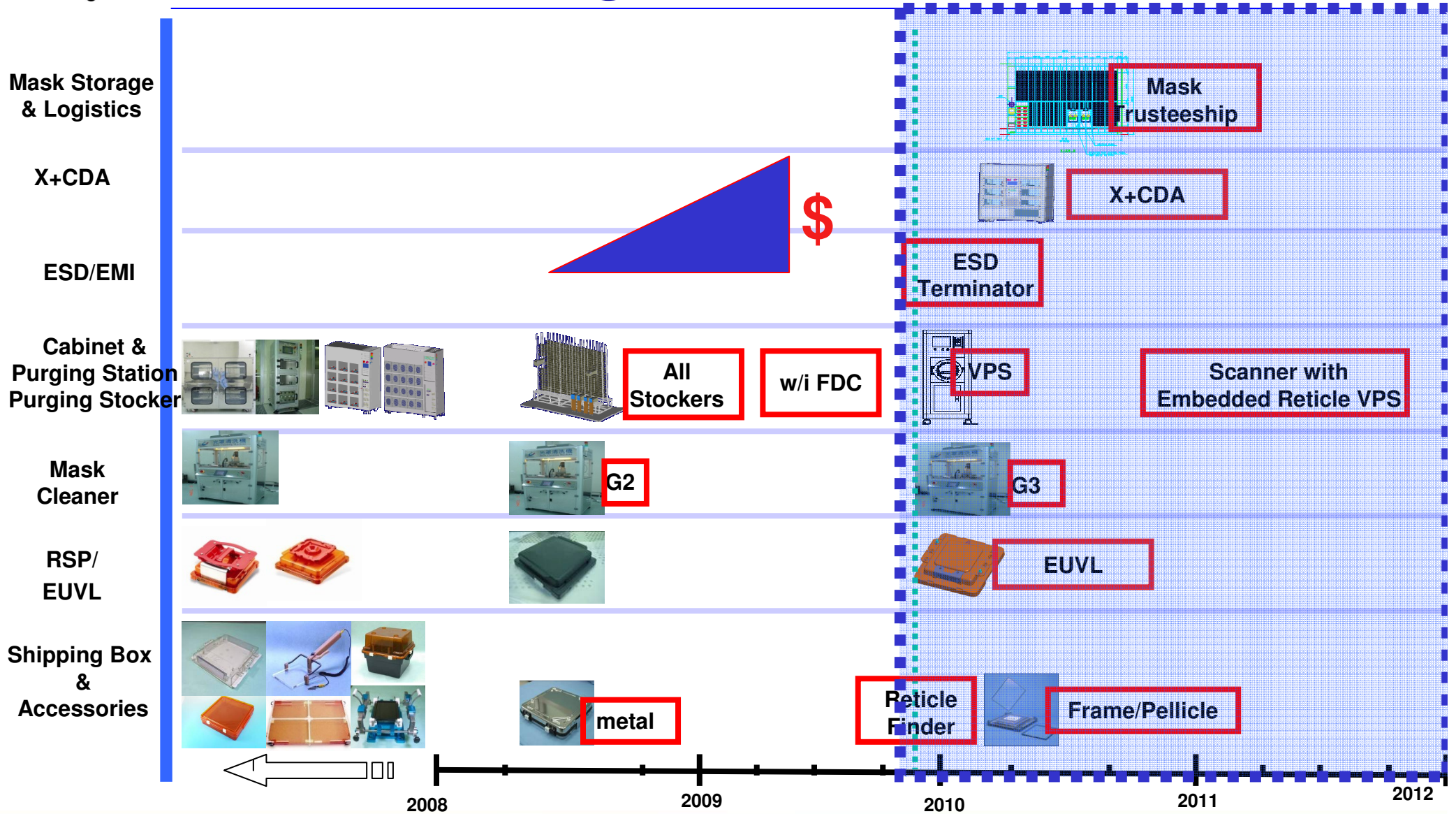

<Wafer Handling Solutions> 產品藍圖

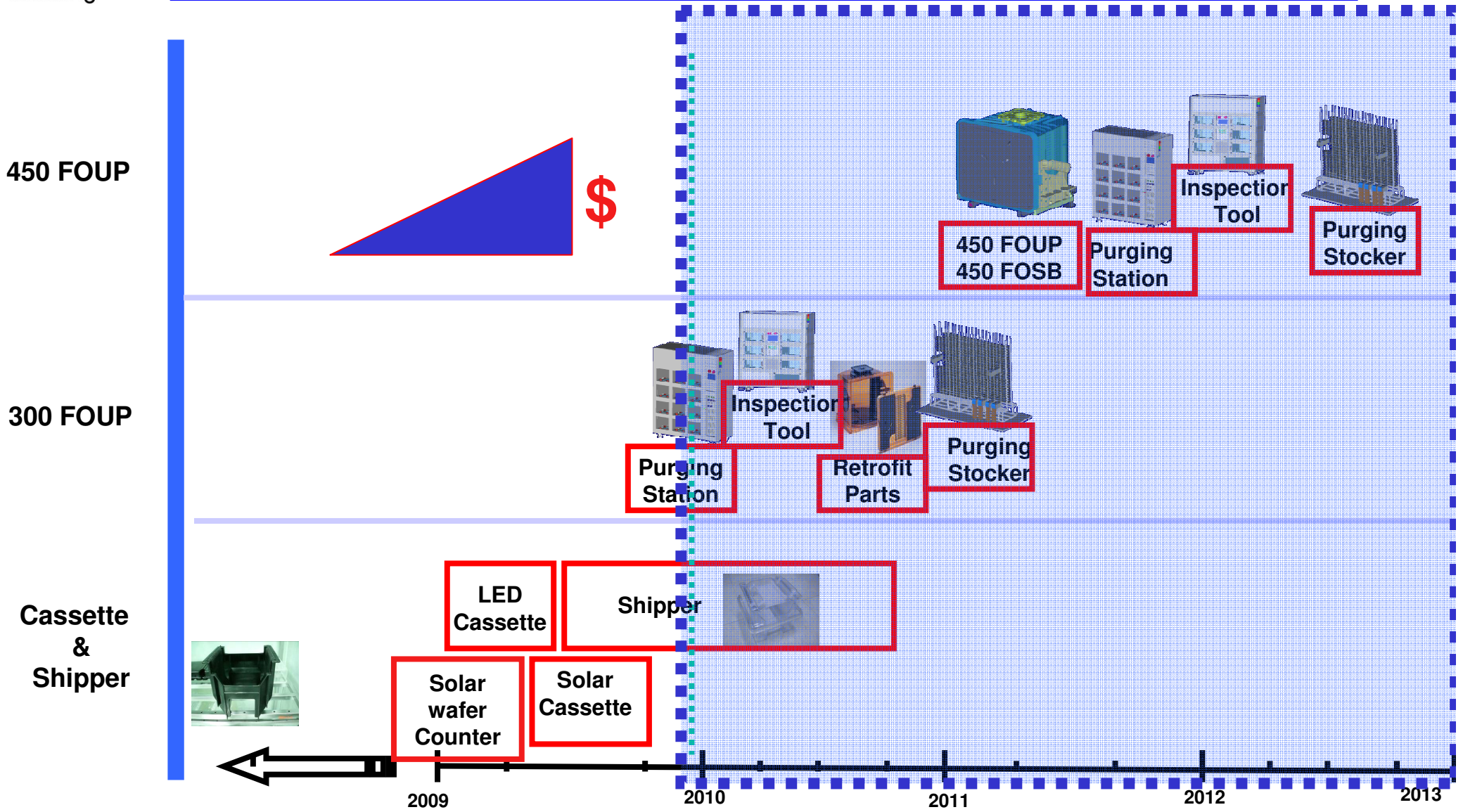

看是尋常最奇絕
成如容易卻艱辛

過
去

橫看成嶺側成峰
遠近高低各不同

未
來

綠葉成蔭子滿枝
久久長長創家登

終
要

Critical Material Handling and Beyond

Critical Material Protection, Transportation & Storage

關鍵性貴重材料元件物品之保護、傳送與儲存解決方案

Thanks for your attentions!

